

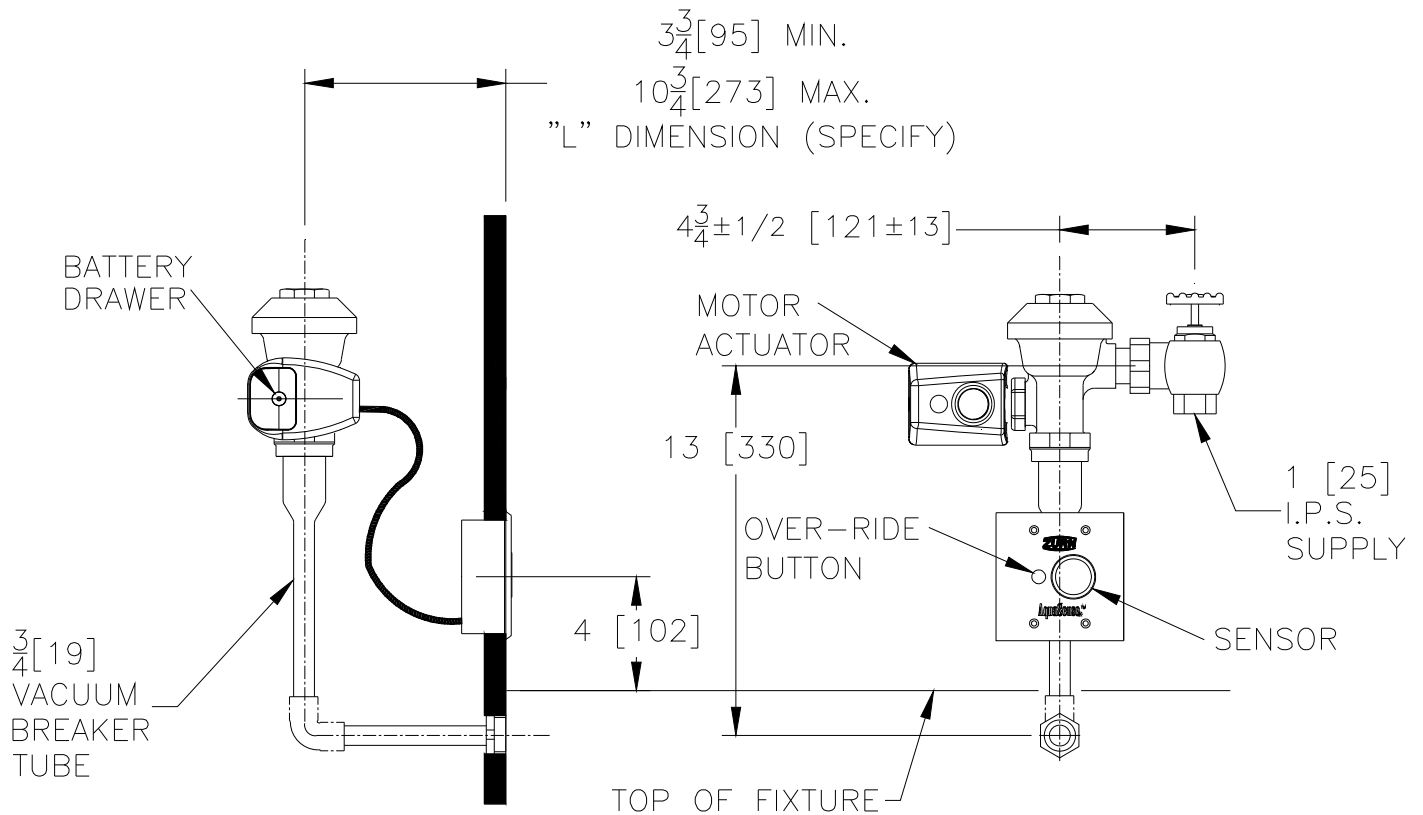

# Concealed ZER6195AV Model Battery Powered Automatic Sensor Flush Valve For Urinals



### Flow Control Options

- EWS 0.5 GPF
- WS1 1.0 GPF
- FF 3.0 GPF
- 1.5 GPF

**ENGINEERING SPECIFICATION: ZURN ZER6195AV AquaSense®AV' Concealed Battery Powered Automatic Sensor Flush Valve For Urinals-** Concealed, quiet diaphragm-type, rough brass, flushometer valve with Zurn's AquaVantage® TPE, chloramine resistant, dual seal diaphragm with a clog resistant triple filtered by-pass. The valve incorporates a 6 VDC motorized actuator, a battery powered automatic sensor with a manual push-button override, high back pressure vacuum breaker, one piece hex coupling nut and adjustable tailpiece, spud coupling and flange for back spud connection. Switchable sensor features include 24 hour auto flush and diagnostic indicator lights. Control stop has internal siphon-guard protection, and a sweat solder kit. Internal seals are made of chloramine resistant materials.

This space is for Architectural/Engineering Approval

The information contained in this document is subject to change without notice. Please contact Zurn for most up to date information.

ZURN INDUSTRIES, LLC. ♦ COMMERCIAL BRASS OPERATION ♦ 5900 ELWIN BUCHANAN DRIVE ♦ SANFORD NC 27330

Phone: 1-800-997-3876 ♦ Fax: 919-775-3541 ♦ World Wide Web: www.zurn.com

In Canada: ZURN INDUSTRIES LIMITED ♦ 3544 Nashua Drive ♦ Mississauga, Ontario L4V1L2 ♦ Phone: 905-405-8272 Fax: 905-405-1292