



# Model ZW5000

## Pressure-Tru® Fire Hose Valve

### Application

The Pressure-Tru® ZW5000 Series Pressure Reducing Valve is listed as a standpipe valve for individual hose stations in CLASS I and CLASS III systems. Regulates pressure under both FLOW and NO-FLOW conditions. Ideal for applications where immediate field adjustments are needed. Can be factory set and adjusted or set in the field as needed

### Standards Compliance

- UL® Listed
- C-UL® Listed

### Material

|                 |                             |                     |
|-----------------|-----------------------------|---------------------|
| Main valve body | Cast bronze                 | ASTM B806           |
| Stem            | Cast bronze                 | ASTM B806           |
| Flange          | Cast bronze                 | ASTM B806           |
| Elastomers      | Buna Nitrile (FDA approved) | EPDM (FDA approved) |
| Springs         | Chrome silicon, ASTM A401   | powder coated       |

### Features

|   |                |
|---|----------------|
| Sizes:  | 2 1/2"         |
| Maximum inlet pressure                                  | 400 psi        |
| End connection (FNPT)                                   | ANSI B1.20.1   |
| (Grooved)   | AWWA C606      |
| (Male hose)   | NFPA1963       |
| Factory or Field Set                                    |                |
| Maximum inlet pressure                                  | 400 psi        |
| Inlet connection (ZW5000)                               | FNPT or Groove |
| Inlet connection (ZW5000F)                              | FNPT           |
| Outlet connection (ZW5000)                              | Male hose      |
| Outlet connection (ZW5000F)                             | FNPT           |
| Factory or Field Set                                    |                |
| Tapped and plugged inlet and outlet for pressure gauge. |                |



PATENT PENDING

ZW5000

### Options

(Suffixes can be combined)

- ZW5000 - angle type valve
- IL - in-line (globe type) valve
- G - with grooved inlet
- SF - with San Francisco hose thread (3")
- ST - with special hose thread
- CC - with cap and chain
- CH - with chrome finish
  
- ZW5000F - female NPT inlet and outlet angle valve
- IL - female NPT inlet and outlet in-line valve
- CH - with chrome finish

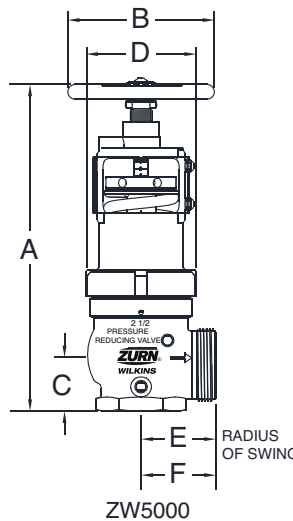

ZW5000

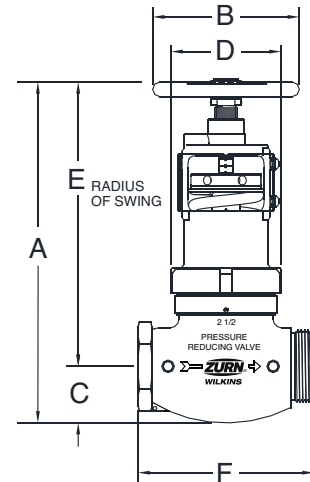

ZW5000IL

### Dimensions & Weights (do not include pkg.)

| MODEL     | DIMENSIONS (approximate) |     |          |     |       |     |       |    |     |     |         |     |        |     |        |      |
|-----------|--------------------------|-----|----------|-----|-------|-----|-------|----|-----|-----|---------|-----|--------|-----|--------|------|
|           | A OPEN                   |     | A CLOSED |     | B     |     | C     |    | D   |     | E       |     | F      |     | WEIGHT |      |
|           | in.                      | mm  | in.      | mm  | in.   | mm  | in.   | mm | in. | mm  | in.     | mm  | in.    | mm  | lbs    | kg   |
| ZW5000    | 13 7/8                   | 352 | 13 3/8   | 340 | 6 1/4 | 159 | 2     | 51 | 5   | 127 | 3 1/2   | 89  | 3 1/4  | 83  | 22.5   | 10.2 |
| ZW5000IL  | 14 1/2                   | 368 | 14       | 356 | 6 1/4 | 159 | 2 1/2 | 64 | 5   | 127 | 12 7/16 | 316 | 7 1/2  | 191 | 26.75  | 12.1 |
| ZW5000G   | 14 1/2                   | 368 | 14       | 356 | 6 1/4 | 159 | 2 1/2 | 64 | 5   | 127 | N/A     | N/A | 3 1/4  | 83  | 22.5   | 10.2 |
| ZW5000ILG | 14 1/2                   | 368 | 14       | 356 | 6 1/4 | 159 | 2 1/2 | 64 | 5   | 127 | N/A     | N/A | 8 3/4  | 222 | 27     | 12.2 |
| ZW5000F   | 13 7/8                   | 352 | 13 1/4   | 337 | 6 1/4 | 159 | 2     | 51 | 5   | 127 | 3 1/2   | 89  | 3 1/16 | 78  | 23     | 10.4 |
| ZW5000FIL | 14 1/2                   | 368 | 14       | 356 | 6 1/4 | 159 | 2 1/2 | 64 | 5   | 127 | 12 7/16 | 316 | 7 1/2  | 191 | 27.25  | 12.4 |
| ZW5000SF  | 13 7/8                   | 352 | 13 3/8   | 340 | 6 1/4 | 159 | 2     | 51 | 5   | 127 | 3 3/4   | 95  | 3 3/8  | 86  | 22.5   | 10.2 |

Zurn Industries, LLC | Wilkins  
 1747 Commerce Way, Paso Robles, CA U.S.A. 93446 Ph. 855-663-9876, Fax 805-238-5766  
 In Canada | Zurn Industries Limited  
 3544 Nashua Drive, Mississauga, Ontario L4V 1L2 Ph. 905-405-8272, Fax 905-405-1292

Rev. C  
 Date: 6/20  
 Document No. FV-ZW5000  
 Product No. Model ZW5000

# Residual Pressure Charts

For Pressure-Tru® 2 1/2" Models

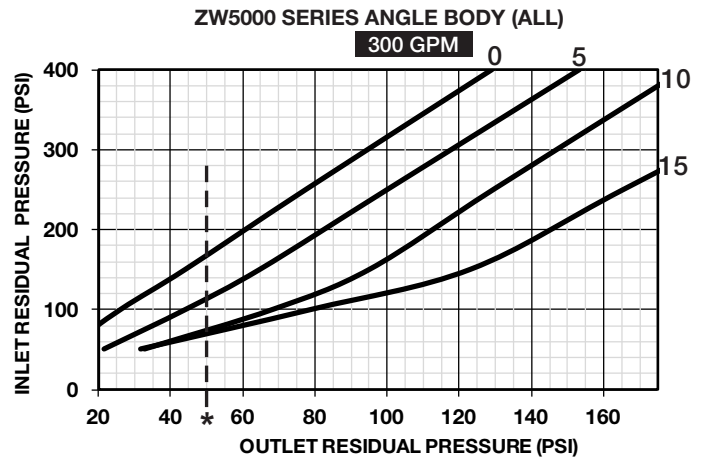
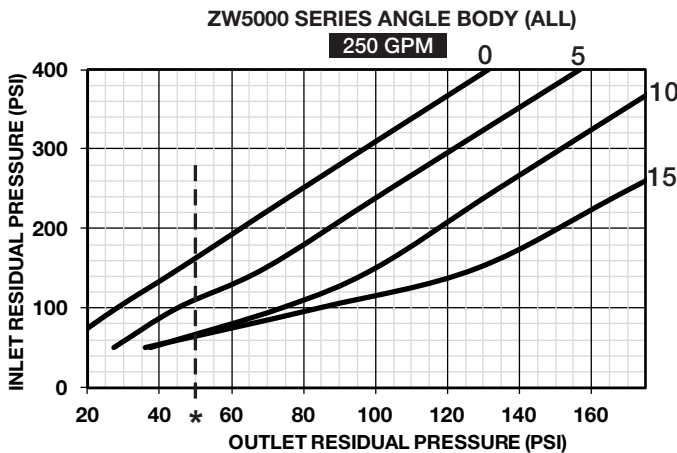
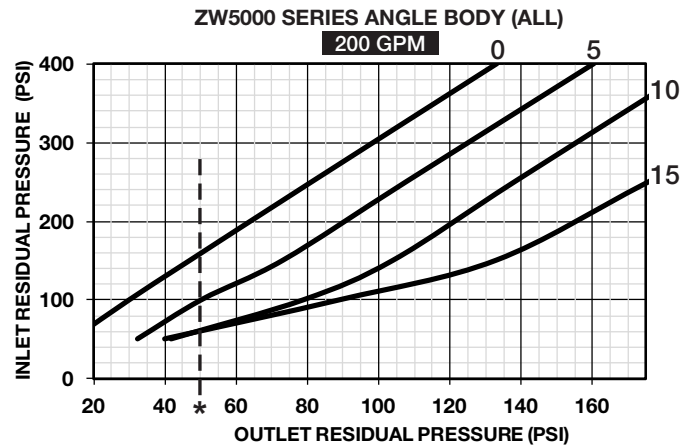
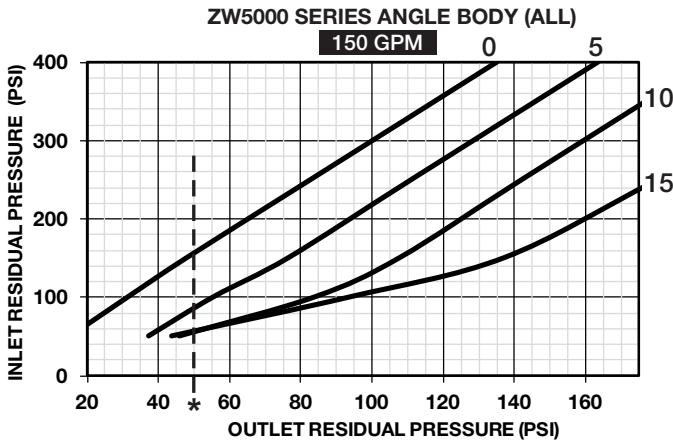
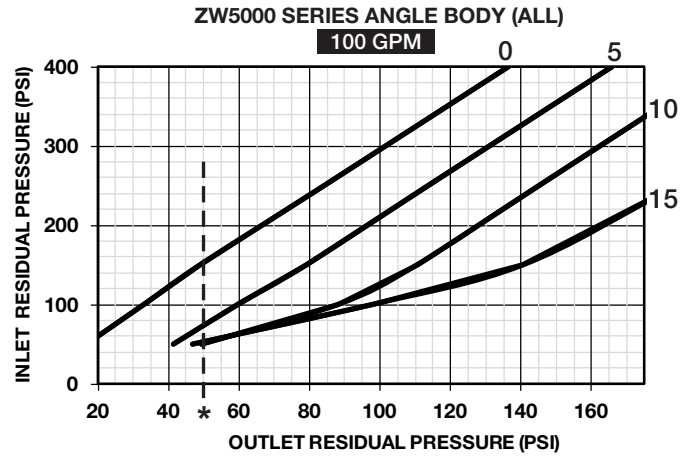
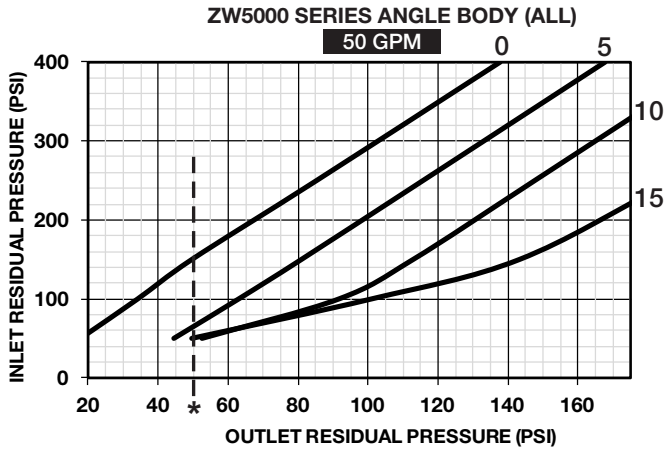

# Residual Pressure Charts

For Pressure-Tru® 2 1/2" Models

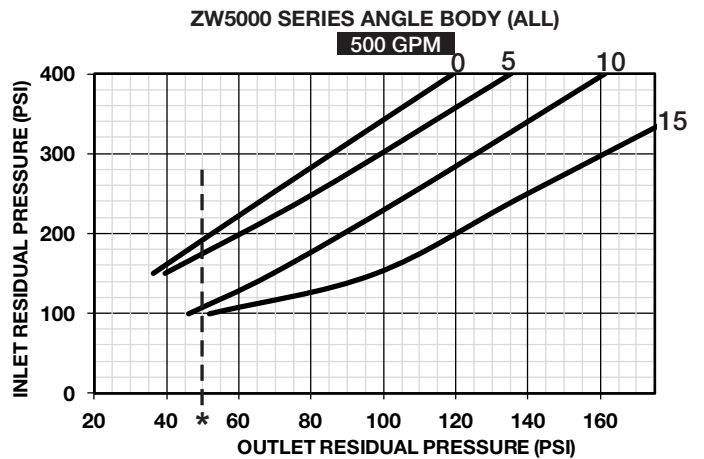
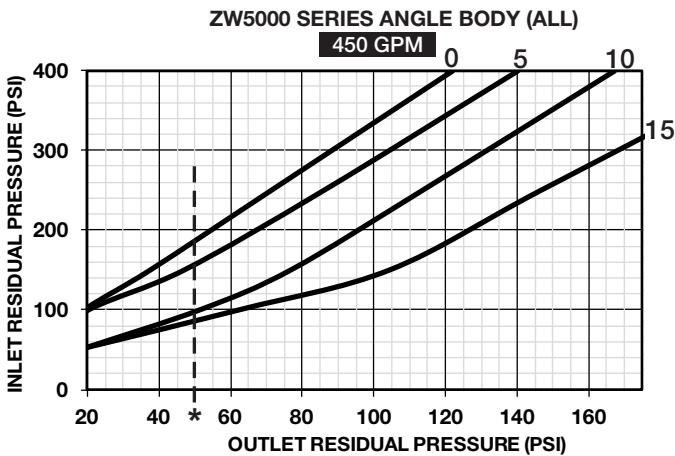
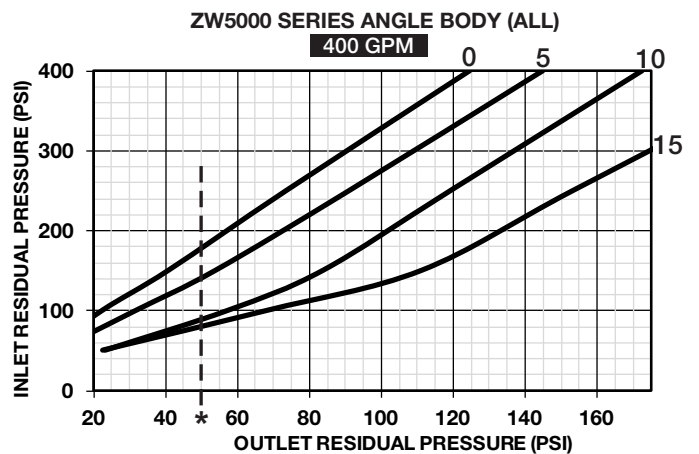
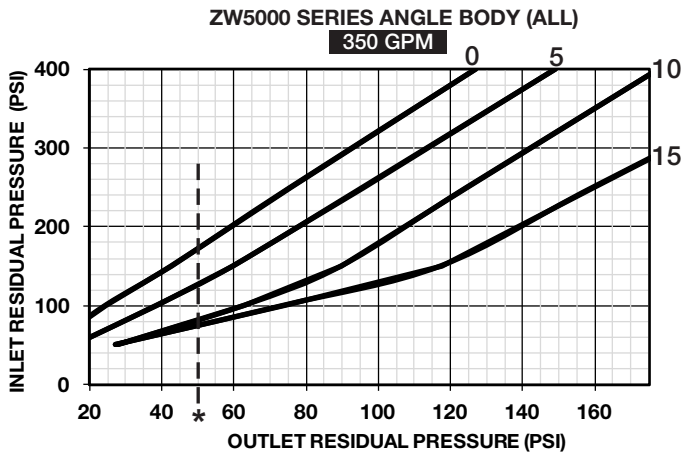

## STATIC PRESSURE CHART

For Pressure-Tru® Angle  
and In-line Valves  
(2-1/2" Inlet and Outlet)

MODELS:  
ZW5000, ZW5004 and ZW5000F  
(ALL)

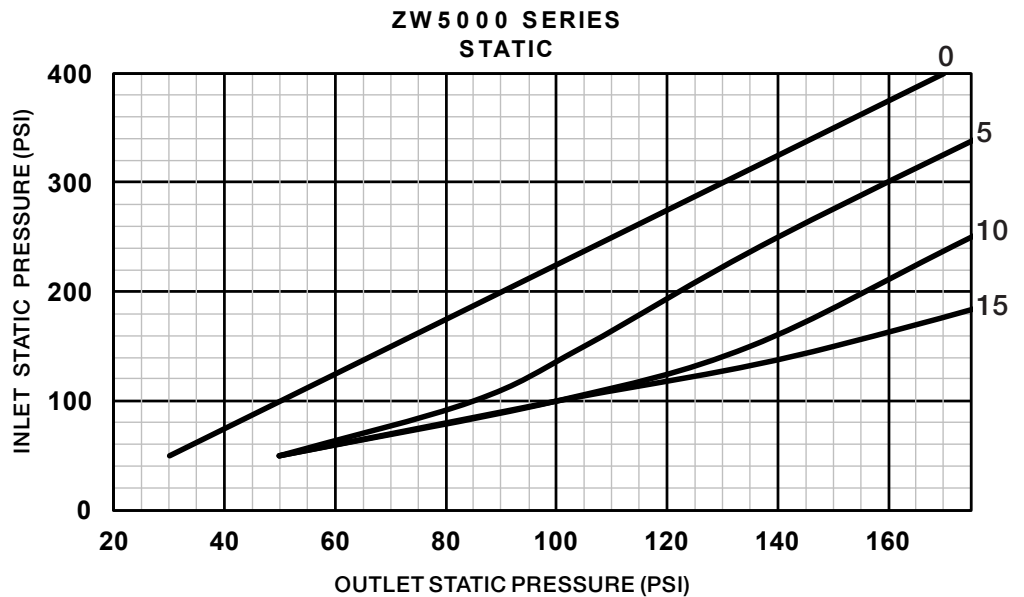

**Note: Curve accuracy= ±5 PSIG \*50 PSI Minimum setting for sprinkler systems**

# Residual Pressure Charts

For Pressure-Tru® 2 1/2" Models

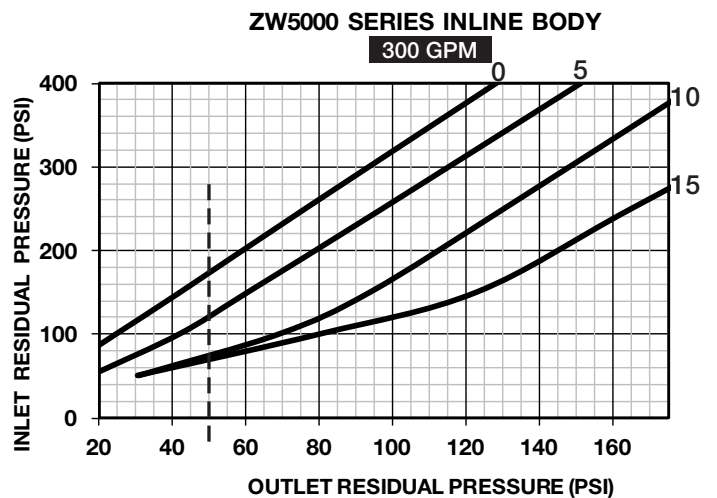
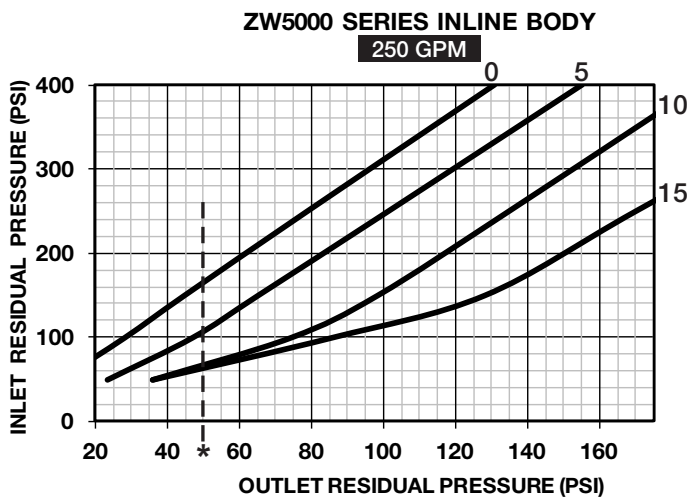
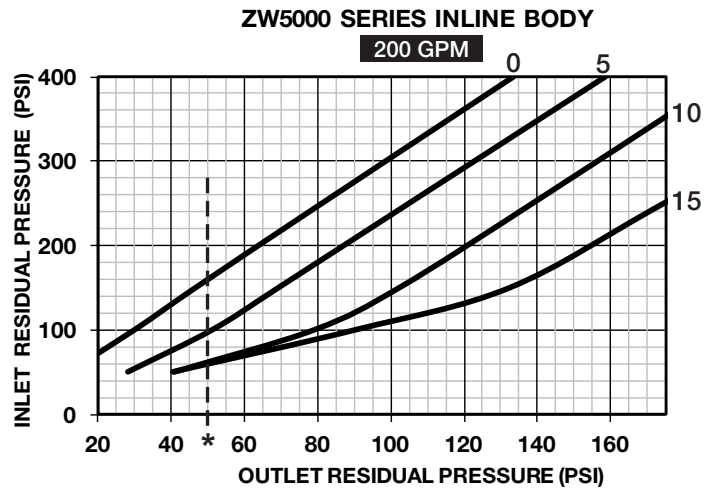
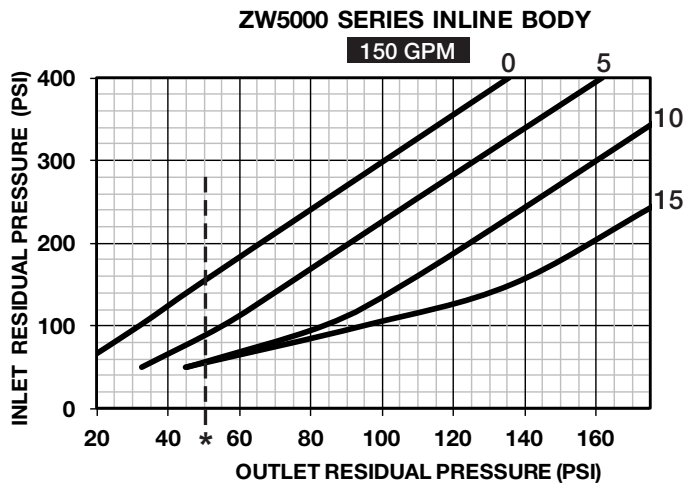
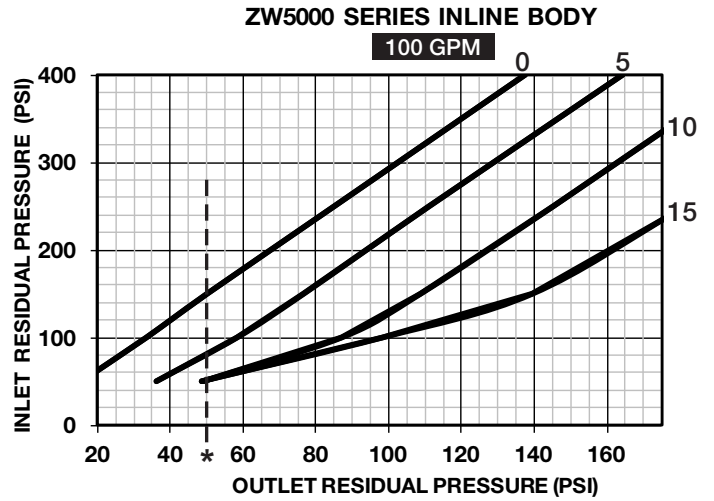
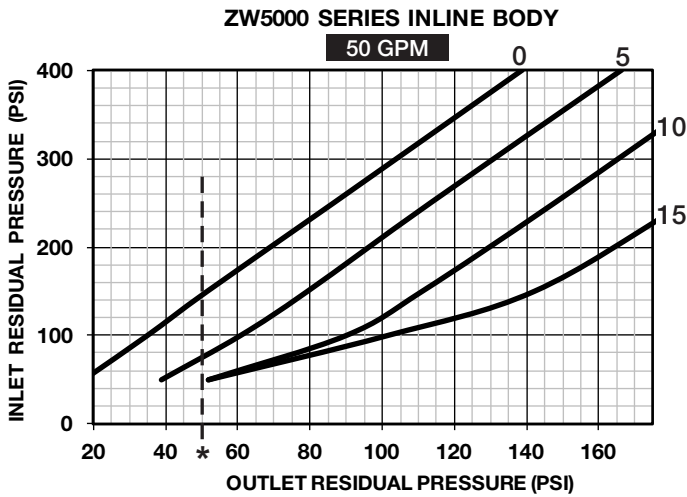

# Residual Pressure Charts

For Pressure-Tru® 2 1/2" Models

ZW5000 SERIES INLINE BODY

350 GPM

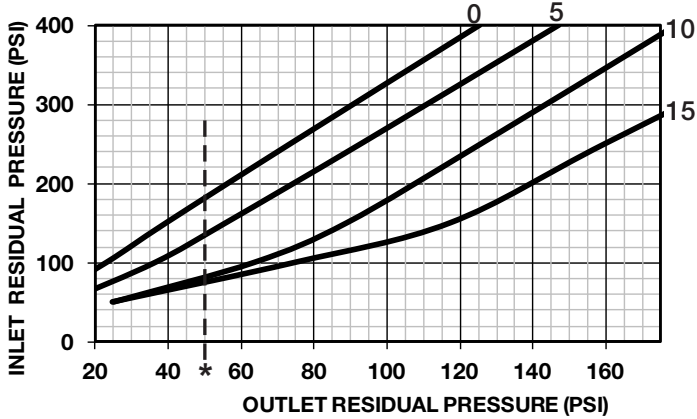

ZW5000 SERIES INLINE BODY

400 GPM

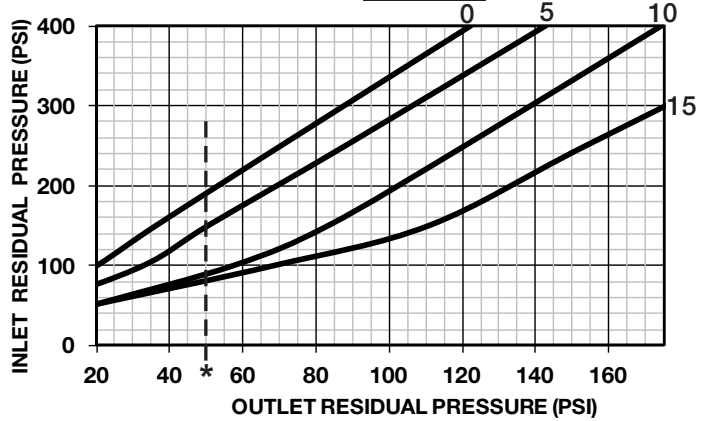

ZW5000 SERIES INLINE BODY

450 GPM

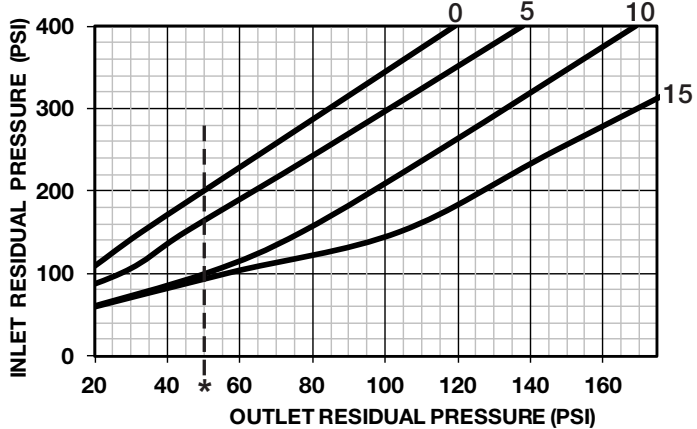

ZW5000 SERIES INLINE BODY

500 GPM

