

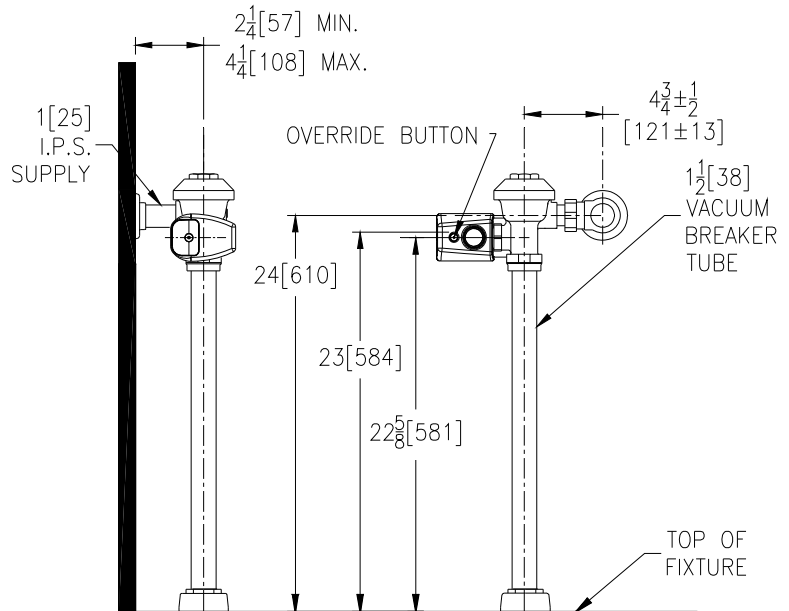

ZER6000AV-WS1-2-CCP

1.6 gpf Sensor Operated Battery Powered Flush Valve for Low Consumption Water Closets



Accessories

- CPM Chrome Plated Metal Cover
- YJ Split Ring Pipe Support
- YK Solid Ring Pipe Support
- _____ Other

ENGINEERING SPECIFICATIONS

Exposed, quiet diaphragm-type, chrome plated flushometer valve with a polished exterior.

- Zurn's AquaVantage® TPE diaphragm
 - Clog Resistant Triple filtered by-pass
 - Chloramine resistant
 - Dual seal
- Proprietary DR resistant low lead brass alloy
- Sensor Module
 - Impact Resistant Chrome Plated Housing
 - ADA compliant
 - 6 VDC Motor Actuator
 - Battery Powered
 - Override Button
 - 10° Angle Sensor High Mount Adapter Kit
- Control Stop
 - Internal siphon-guard protection
 - Vandal resistant stop cap
 - Sweat solder kit
 - Cast wall flange with set screw
- Vacuum Breaker
 - High back pressure
 - One piece hex coupling nut
- Internal seals
 - Chloramine resistant
- Adjustable tailpiece
- Spud coupling and flange for top spud connection

Architectural/Engineering Approval

The information contained in this document is subject to change without notice.
Please contact Zurn for most up to date information.

ZURN INDUSTRIES, LLC. ♦ COMMERCIAL BRASS OPERATION
5900 ELWIN BUCHANAN DRIVE ♦ SANFORD NC 27330
PHONE: 1-800-997-3876 ♦ FAX: 919-775-3541
WWW.ZURN.COM
IN CANADA: ZURN INDUSTRIES LIMITED
3544 NASHUA DRIVE ♦ MISSISSAUGA, ONTARIO L4V1L2
PHONE: 905-405-8272 FAX: 905-405-1292

AquaVantage® is a registered trademark of Zurn Industries, LLC.
AquaSense® is a registered trademark of Zurn Industries, LLC.

Rev. -
Dwg. No. 309045

Date: 2/20/12
Product No. ZER6000AV-WS1-2-CCP